

External Appearance

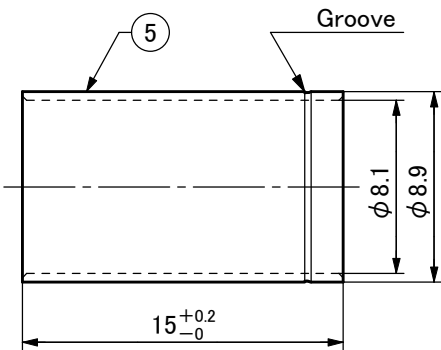

Construction

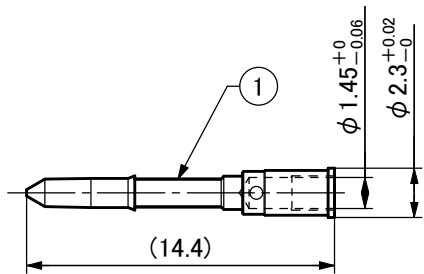
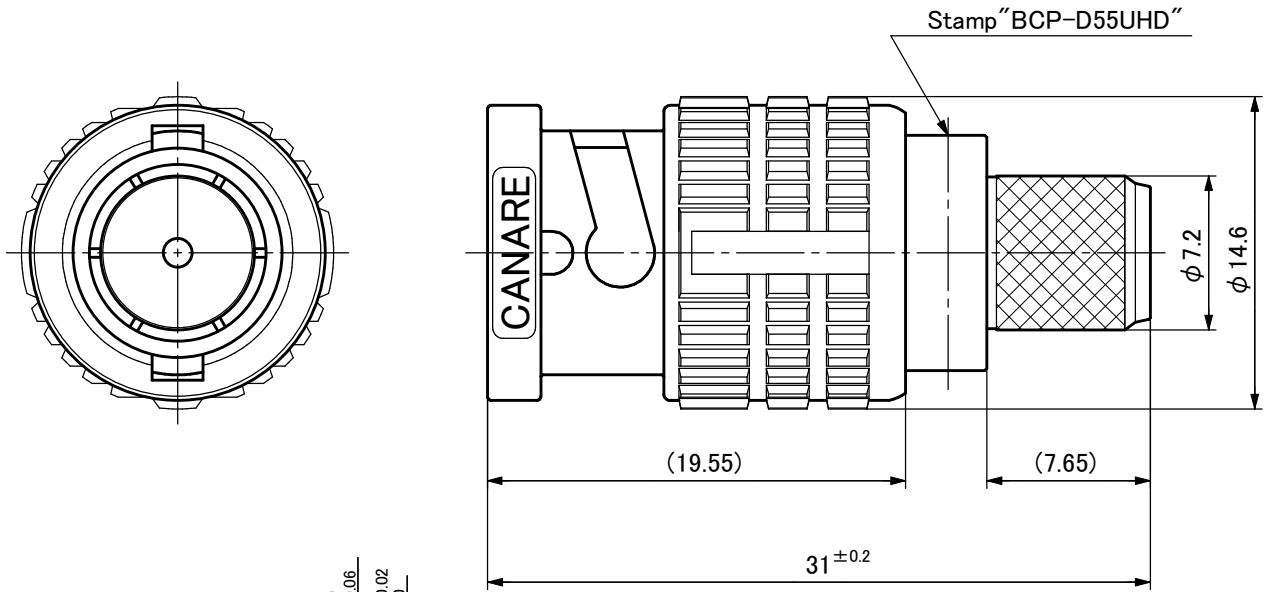
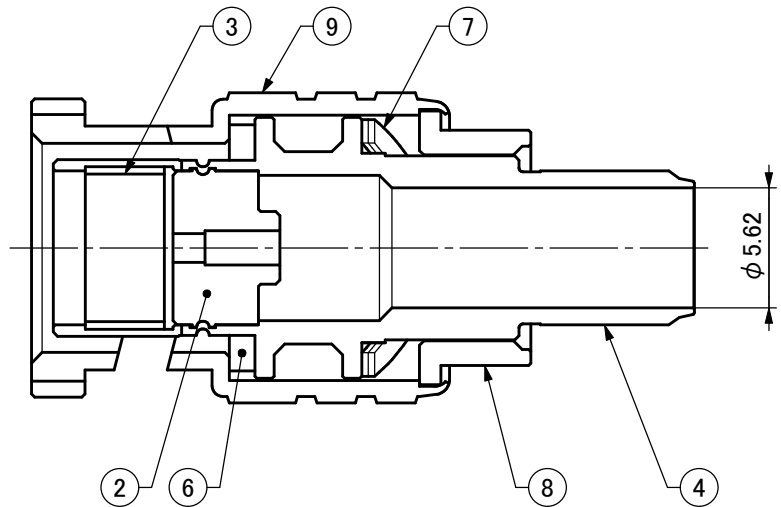

9	Coupling Sleeve	1	Zinc Alloy Die Casting	Nickel Plating					
8	Washer	1	Brass	Nickel Plating					
7	Spring Washer	2	Beryllium Copper	Nickel Plating					
6	Gasket	1	Silicone Rubber	—					
5	Crimp Sleeve	1	Copper	Tin Plating					
4	Body	1	Brass	Nickel Plating					
3	Inner Spring	1	Beryllium Copper	Nickel Plating					
2	Insulator	1	PTFE	—					
1	Male Center Contact	1	Brass	Gold Plating					
No.	Name of Parts	Pc(s).	Material	Finish					
Title	CRIMP TYPE	PJTN	Unit	Sc.	Tol.	Date	Ver. 1.0	Model	No.
	75 Ω BNC PLUG		mm	2√2:1	±0.1	2017-01-06		BCP-D55UHD	BL497